



GSSA 300 schwarz/black

Industrial Connectors:Rectangular connectors GDM-series:Type C Industrial
Standard:Appliance connector

Product description

Description	appliance connector with central nut and 2 screws M 3 x 8
Type	GSSA 300 schwarz/black
Order No.	933 116-100
Number of contacts	3 + PE
Standard	industrial standard (9.4 mm)
Housing Color	black
Construction type	C

Drawing

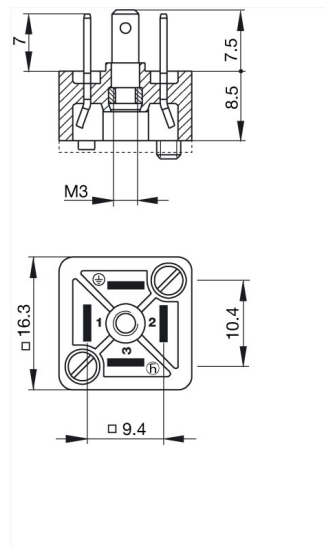

Technical data

Rated voltage	UC 250 V
Rated current	4 A
Contact resistance	≤ 4 mOhm
Type of termination	solder
Mounting	screw

Material

Contact surface material	Sn
Contact bearer material	PA
Housing material	PA

Environmental conditions

Protection class (IEC 60529)	IP 65
Pollution severity	3
Temperature range	-40 °C to +125 °C

Inflammability class

Housing	94 HB
Contact bearer	94 V-2

Approvals

UR	UR
VDE	VDE
SEV	SEV
CSA	CSA
Packaging unit	
Packaging unit	200 pieces
Scope of delivery and accessories	
Accessories to order separately	(NBR) flat gasket GSSA 300-5, Order No. 730 233-002; (EPDM) flat gasket GSSA 300-6, Order No. 730 312-003